

# DENON

## AVR-3313

INTEGRATED NETWORK AV RECEIVER

# Getting Started

# Welcome

Thank you for choosing a DENON receiver. This guide provides step-by-step instructions for setting up your receiver.

## **If you have setup problems:**

If you need additional help in solving problems, contact DENON customer service in your area.

See the address sheet included in the box.

# Before You Begin

## What's In the Box

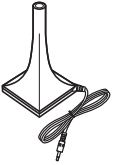
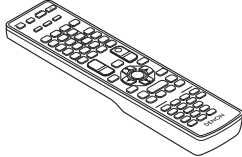
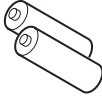
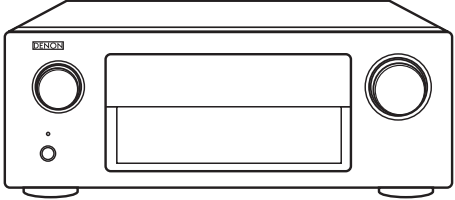
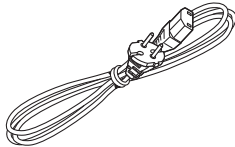
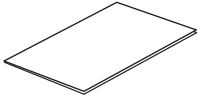
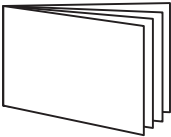
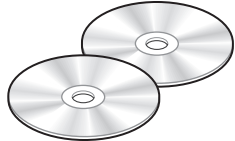
 <p>Setup microphone</p>	 <p>Remote control unit</p>	 <p>R6/AA batteries</p>
 <p>Receiver</p>		 <p>Power cord</p>
 <p>Safety Instructions</p>	 <p>Getting Started</p>	 <p>Owner's Manual</p>

## Required for setup

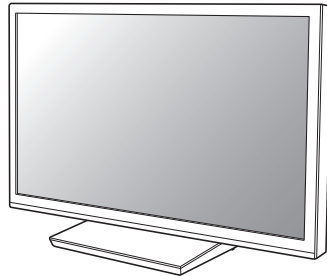
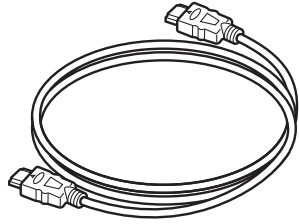
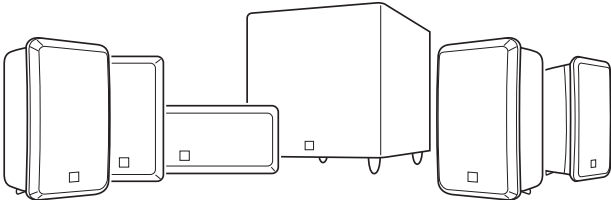
 <p>TV</p>	 <p>HDMI cable</p>
 <p>Speaker systems</p>	



Note that the illustrations in this manual is for explanation purposes and may differ from the actual unit.

# Setup Steps

There are three steps to the setup process.

**1** Install batteries in the remote control unit

**2** Connect the receiver to your TV

**3** Follow the On-Screen Setup Assistant

## **1** Installing batteries in the remote control unit

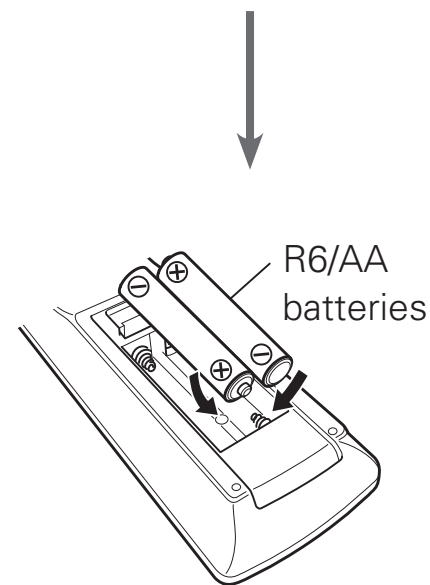
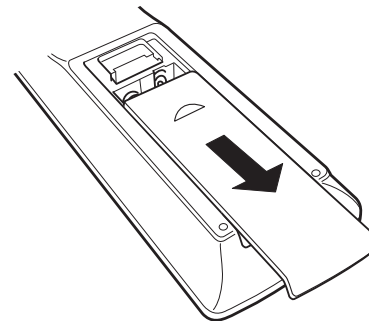

## 2 Connecting the receiver to your TV

□ Place the receiver near your TV.

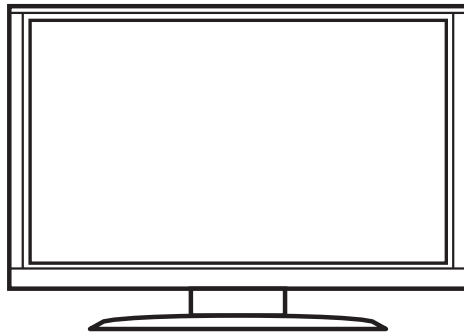

TV

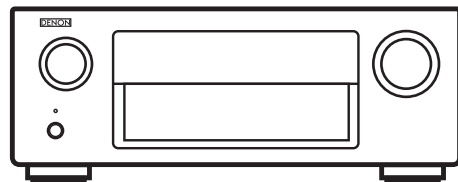

Receiver

□ Connect the receiver to your TV with an HDMI cable.

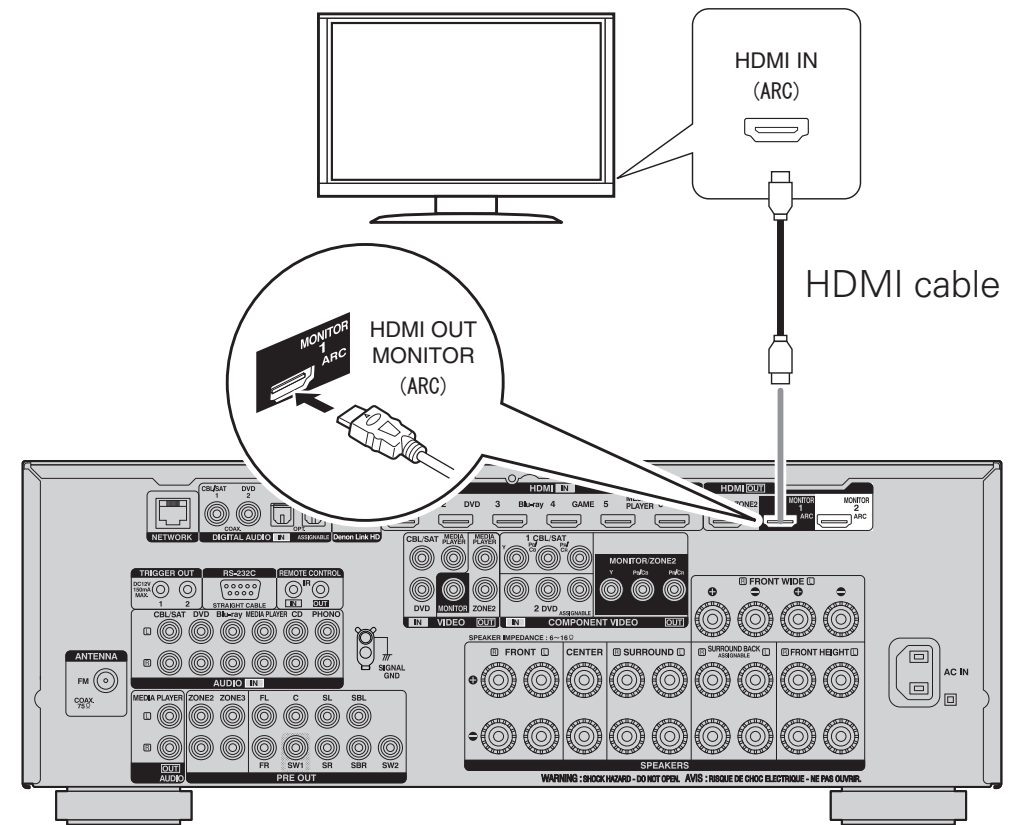

Receiver (Rear panel)

❑ Turn on the TV.

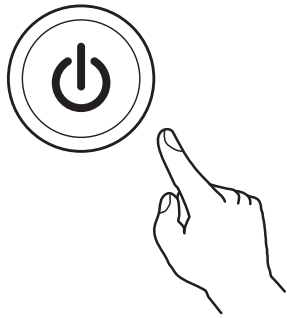
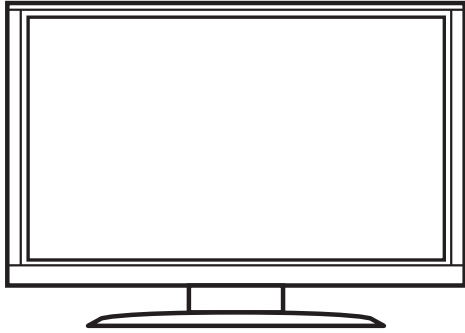

TV remote control unit

❑ Select the appropriate HDMI input on your TV.

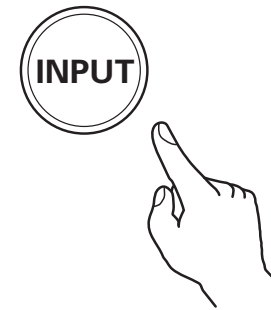
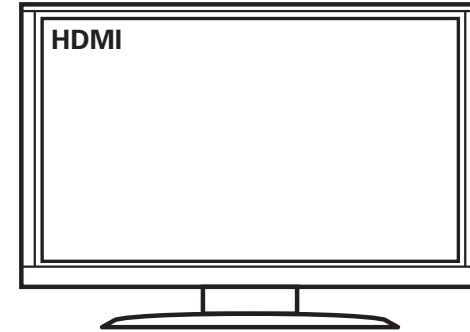

TV remote control unit

# Turn on receiver.

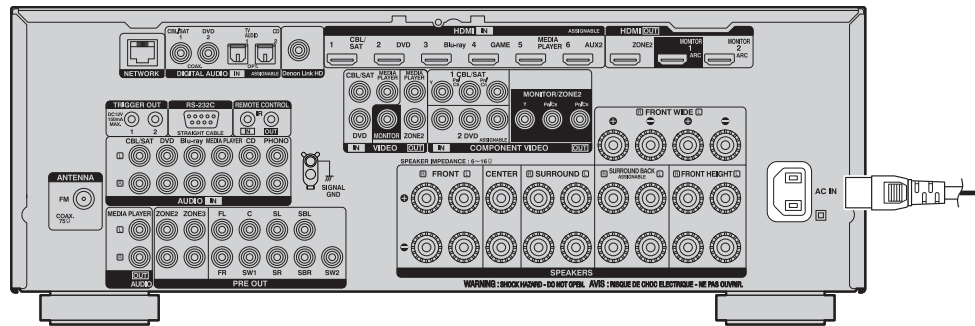

Connect to household power outlet  
(AC 230 V, 50/60 Hz)



Power cord  
(supplied)

- Turn on receiver as shown below.

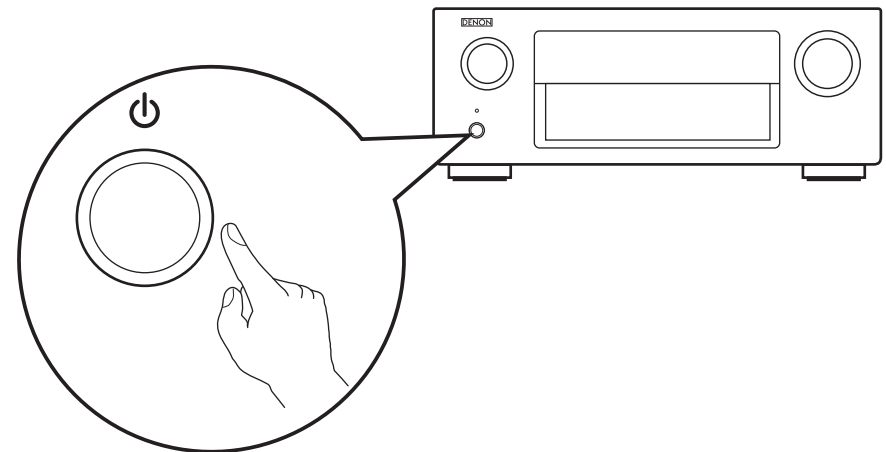

# 3 Follow the On-Screen Setup Assistant

The Setup Assistant will walk you through connecting and configuring your speakers and components to your DENON receiver. Please use the remote control and follow the on-screen instructions.

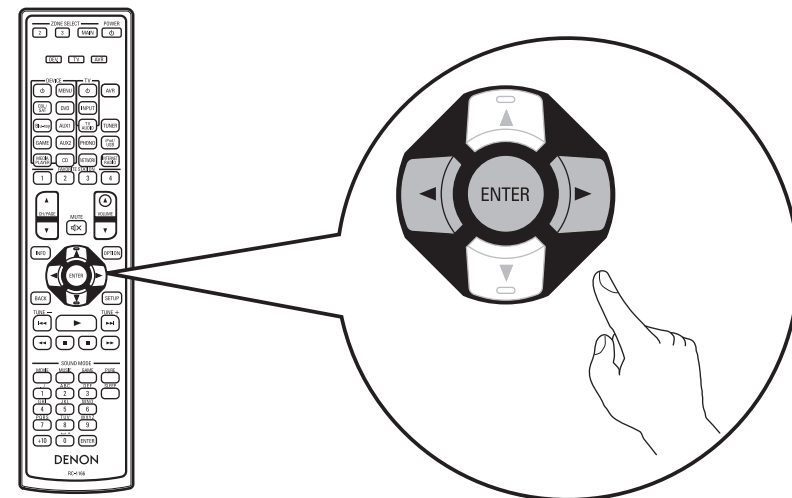
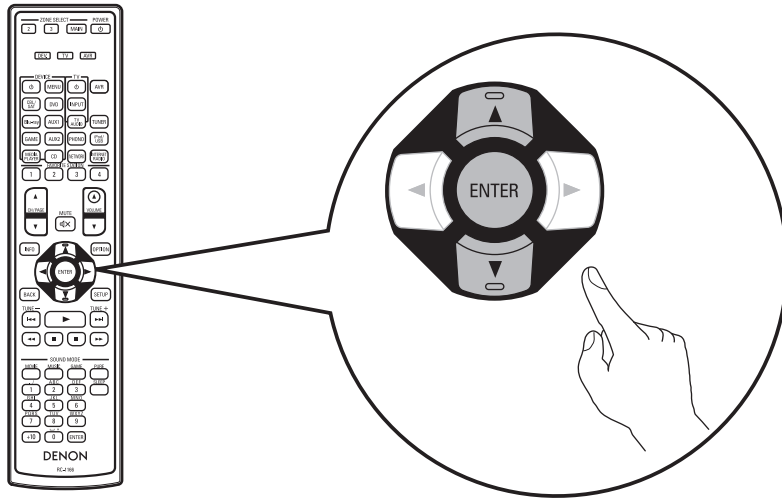
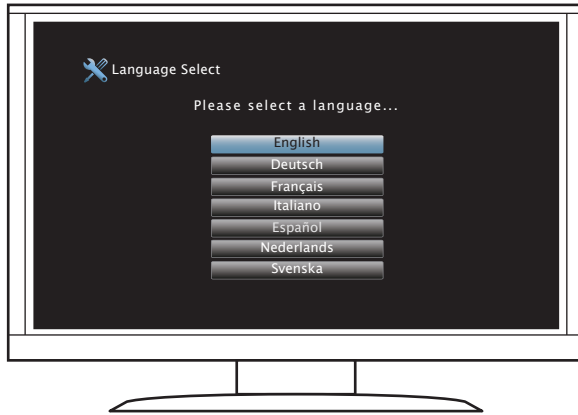



# Owner's Manual

The included CD-ROM contains an Adobe PDF version of the full owner's manual for the AV receiver. Please reference this manual for more details about the setup and operation of the receiver and its features.

**1** Insert the disc into your PC.

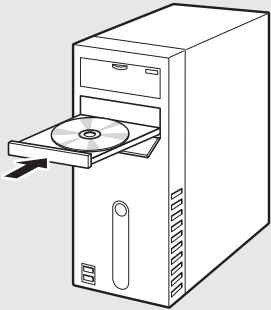

**2** Follow the screen or double click on the PDF file.

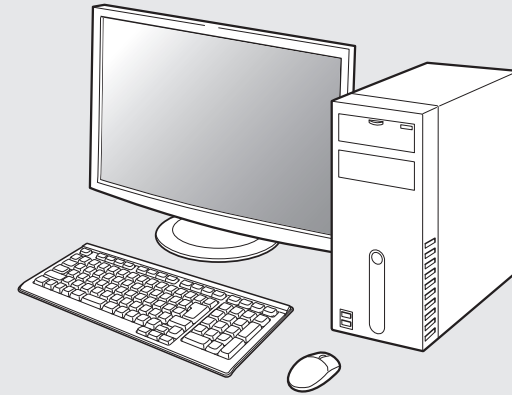

V00

**DENON**  
[www.denon.com](http://www.denon.com)

D&M Holdings Inc.  
Printed in China 5411 10778 00AD